

■ Switching Diodes

■ Features

- Low forward voltage. : $V_F(3)=0.92V$ (Typ.)
- Fast reverse recovery time : $t_{rr}=1.6ns$ (Typ.)
- Small total capacitance : $C_T=2.2pF$ (Typ.)

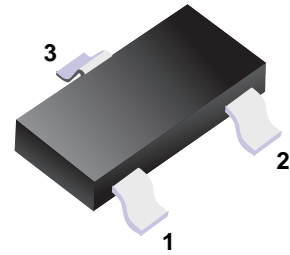

■ Simplified outline(SOT-23)

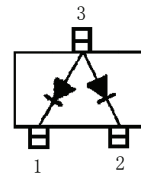

■ Marking

Marking	A3
---------	----

■ Absolute Maximum Ratings  $T_a = 25\text{ }^\circ\text{C}$

Parameter	Symbol	Rating	Unit
Peak reverse voltage	$V_{RM}$	85	V
Reverse voltage	$V_R$	80	V
Average forward current	$I_o$	100	mA
Peak forward current	$I_{FM}$	300	mA
Surge current (10ms)	$I_{FSM}$	2	A
Power dissipation	P	150	mW
Junction temperature	$T_j$	125	$^\circ\text{C}$
Storage temperature	$T_{stg}$	-55 to +125	$^\circ\text{C}$

■ Electrical Characteristics  $T_a = 25\text{ }^\circ\text{C}$

Parameter	Symbol	Test Conditions	Min	Typ	Max	Unit
Reverse breakdown voltage	$V_R$	$I_R=100\text{ }\mu\text{A}$	80			V
Forward voltage	$V_{F1}$	$I_F=1\text{ mA}$		0.61		
	$V_{F2}$	$I_F=10\text{ mA}$		0.74		
	$V_{F3}$	$I_F=100\text{ mA}$		0.92	1.2	
Reverse voltage leakage current	$I_{R1}$	$V_R=30\text{ V}$			0.1	$\mu\text{A}$
	$I_{R2}$	$V_R=80\text{ V}$			0.5	
Capacitance between terminals	$C_T$	$V_R=0\text{ V}, f=1\text{ MHz}$		2.2	4	pF
Reverse recovery time	$t_{rr}$	$I_F=10\text{ mA}$		1.6	4	ns

■ Typical Characteristics

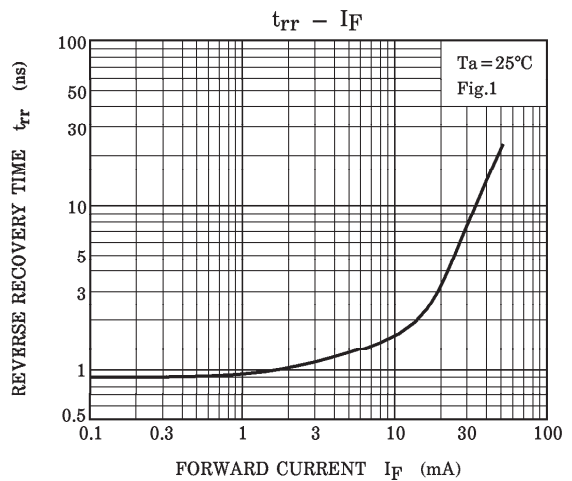
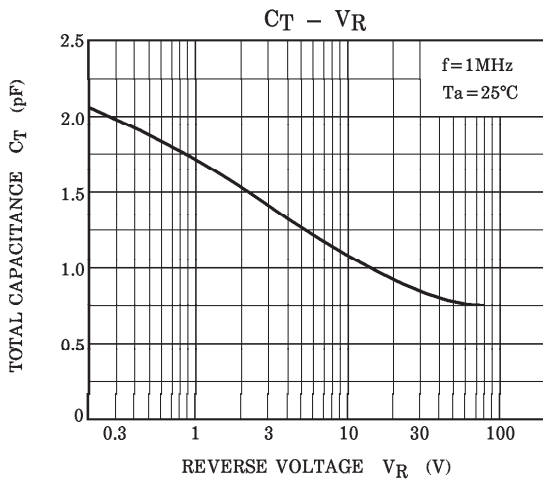
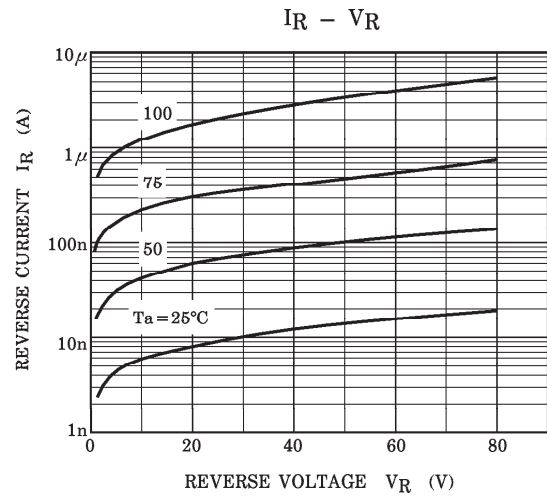
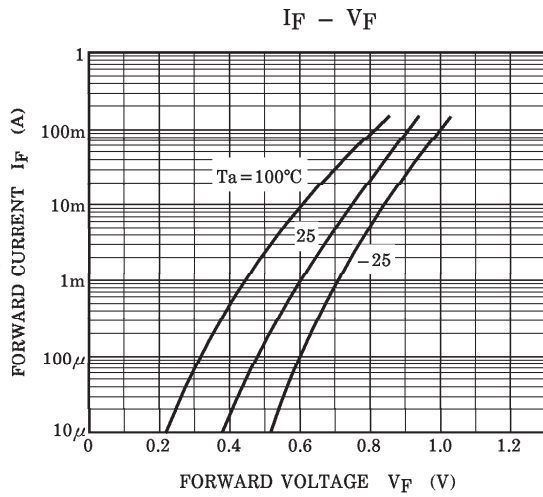

■ SOT-23

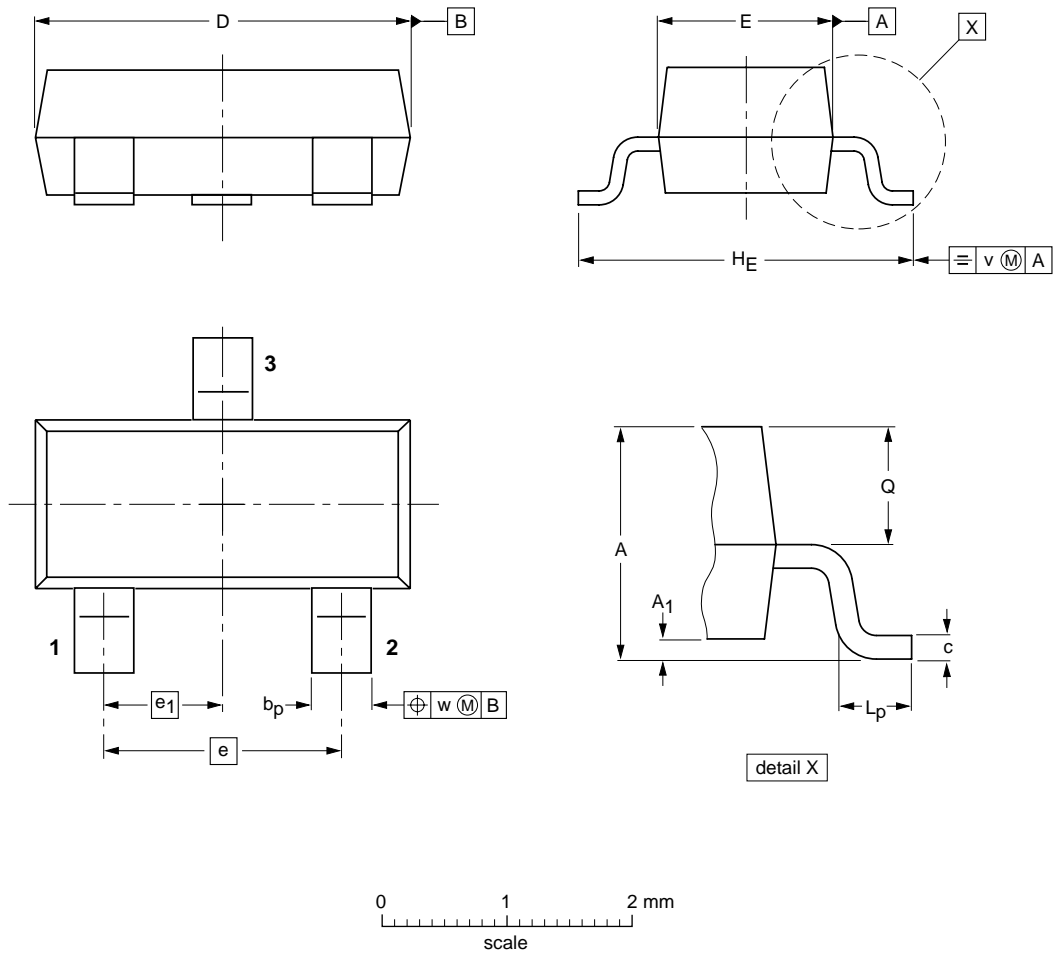

DIMENSIONS (mm are the original dimensions)

UNIT	A	A <sub>1</sub> max.	b <sub>p</sub>	c	D	E	e	e <sub>1</sub>	H <sub>E</sub>	L <sub>p</sub>	Q	v	w
mm	1.1 0.9	0.1	0.48 0.38	0.15 0.09	3.0 2.8	1.4 1.2	1.9	0.95	2.5 2.1	0.45 0.15	0.55 0.45	0.2	0.1